



ELSYS

PART OF
BEMSIQ
GROUP

Operating manual

ERS Display Series LoRa

ERS Display Lite LoRa

ERS Display CO2 Lite LoRa

ERS Touch LoRa

ERS Display LoRa

ERS Display CO2 LoRa

ERS Display Sound LoRa

ERS Display VOC LoRa



Address

Tvistevägen 48
90736 Umeå
Sweden

Webpage

www.elsys.se

E-mail

support@elsys.se

Important Safety Information



Read this manual before attempting to install the device.

Failure to observe the recommendations included in this manual may be dangerous or cause a violation of the law. The manufacturer, ElektronikSystem i Umeå AB, will not be held responsible for any loss or damage resulting from not following the instructions of this operating manual.

- The device must not be dismantled or modified in any way.
- The device is only intended for indoor use. Do not expose it to moisture.
- The device is not intended to be used as a reference sensor, and ElektronikSystem i Umeå AB will not be held liable for any damage which may result from inaccurate readings.
- The battery should be removed from the device if it is not to be used for an extended period. Otherwise, the battery might leak and damage the device. Never leave a discharged battery in the battery compartment.
- The device must never be subjected to shocks or impacts.
- To clean the device, wipe with a soft moistened cloth. Use another soft, dry cloth to wipe dry. Do not use any detergent or alcohol to clean the device.
- CAUTION – Risk of explosion if the battery is replaced by an incorrect type



Disposal note in accordance with Waste from Electrical and Electronic Equipment (WEEE) Directive 2012/19/EU

The device, as well as all the individual parts, must not be disposed of with household waste or industrial waste. You are obliged to dispose of the device at the end of its service life in accordance with the requirements of Directive 2012/19/EU to protect the environment and to reduce waste through recycling. For additional information and how to carry out disposal, please contact the certified disposal service providers. The sensors contain a lithium battery, which must be disposed of separately.

Table of content

Contents

Important Safety Information	2
Electronic Equipment (WEEE) Directive 2012/19/EU	2
Table of content	3
1.1 Description	5
1.2 ERS Display Series Attributes	5
1.3 Label	5
1.4 Dimensions	6
1.5 Main features of the ERS Display Series	7
2 Mounting Guidelines	8
2.1 Motion PIR	8
2.2 Sound Level	8
3.1 Installation	9
3.2 Service and Maintenance	10
4 Sensor Configuration	11
4.1 NFC Configuration	11
4.2 Over the Air Configuration	11
4.3 Application Parameters	12
5.1 Display	12
5.2 Onscreen sensor data	14
5.2.2 ERS Display CO2 Lite, ERS Display CO2	14
5.2.3 ERS Display Sound	14
5.2.4 ERS Display VOC	14
5.3 Custom Interface	15
6.1 Sensor Startup	15
6.3 Scheduled Transmission	16
6.4 LED Indication	16
7.1 Temperature Sensor	17
7.2 Humidity Sensor	17
7.3 Light Sensor	18
7.4 CO ₂ Sensor	18
7.5 VOC Sensor	19
7.6 Motion PIR Sensor	20
7.7 Sound Level Sensor	21



8.2 Sensor Payload Format	23
9.1 Legal Notices	24
9.2 Federal Communication Commission Interference Statement	24
Notice	24
Note	24
9.3 Declaration of Conformity	25

1.1 Description

The Display series of sensors are universal LoRaWAN® indoor climate sensors with a 2.1" E-paper display showing real-time sensor data. Depending on the model, the sensor measures temperature, humidity, light intensity, CO2 level, VOC level, and sound level and detects motion. The Display series are battery-powered devices and are designed to be wall-mounted. The sensors are equipped with NFC (Near Field Communication) for easy configuration with an NFC-enabled smartphone.

1.2 ERS Display Series Attributes

	ERS Display Lite LoRa	ERS Display Lite CO2 LoRa	ERS Touch LoRa	ERS Display LoRa	ERS Display CO2 LoRa	ERS Display VOC LoRa	ERS Display Sound LoRa
2.13" display	x	x	x	x	x	x	x
NFC	x	x	x	x	x	x	x
Temp	x	x	x	x	x	x	x
Hum	x	x	x	x	x	x	x
Light				x	x	x	x
Motion PIR				x	x	x	x
CO2		x			x		
VOC						x	
Sound							x
Touch Input function			x				

1.3 Label

The barcode is of type Aztec and contains DevEUI and sensor type.

This label is located at the back of your device.

1.4 Dimensions

Measurements are given in millimeters.

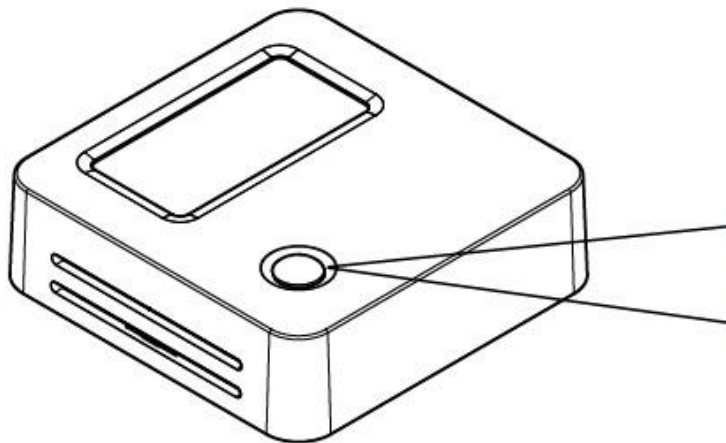
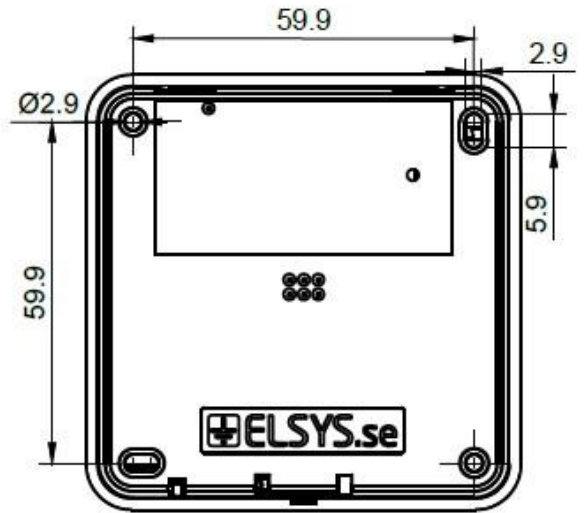
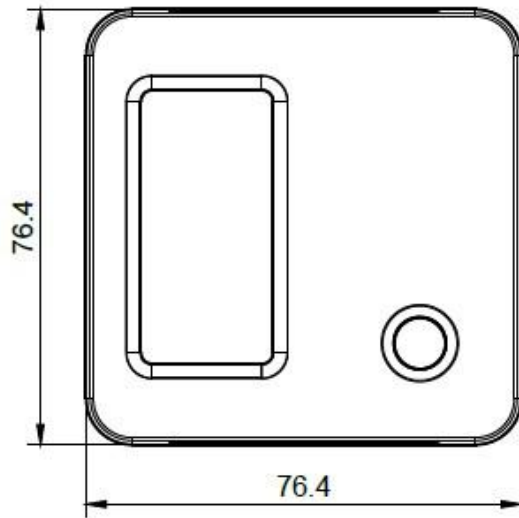

LED
Motion Detector
Light Sensor

1.5 Main features of the ERS Display Series LoRa

- Compatible with LoRaWAN® specification 1.0.4
- Presents real-time data on a 2.1" e-paper display
- Measures ambient temperature
- Measures ambient humidity
- Measures light intensity*
- Measures CO2-level*
- Measures VOC level*
- Measures sound-level*
- Detects room occupancy*
- Detect motion using a passive IR sensor*
- Indicates high or low values with an LED light*
- Easy installation
- Easy configuration
- May be installed on a wall or any (non-metallic) surface
- Battery-powered
- Long-range communication
- Configurable over NFC
- Configurable over the air
- Ten years of battery life**
- Supported channel plans: EU863-870, IN865, US915, AU915-928, AS923, HK923, KR923
- CE Approved and RoHS compliant

* *Depending on model*

** *Depending on settings and environmental factors*

2 Mounting Guidelines

Common mounting guidelines for ERS Display Series LoRa line of sensors:

- Place the sensor in an open space on the wall, with an installation height of 1.6 meters.
- For best RF and measurement performance, make sure you mount the sensor with the ventilation openings vertically. See installation in chapter 3.
- Make sure that the sensor is not placed in direct sunlight, close to heating vents, near windows, air ventilation where it may measure values that are not representative of the rest of the room.

NOTE: Do not place the display in a very bright light, e.g. Direct sunlight can temporarily affect the contrast of the screen.

2.1 Motion PIR

The PIR can self-trigger if multiple sensors with PIR are placed too close to each other. Keep this in mind when you mount or test the sensors.

2.2 Sound Level

Think carefully about the placement of the ERS Display Sound LoRa. If the sensor is placed close to loud sources such as machines or ventilation, it will be reflected in the sensor readings due to sounds being louder closer to the source.

3.1 Installation

1. Remove the back panel of the sensor by gently prying the tab with a small screwdriver. Take care not to damage any internal components.



2. Install the batteries. The ERS Display Series LoRa requires one or two AA batteries. The battery type is 3.6V Lithium Battery (ER14505). You can use one battery, but it's recommended that you use two for best performance and battery life. Use battery slot A if only one battery is used.

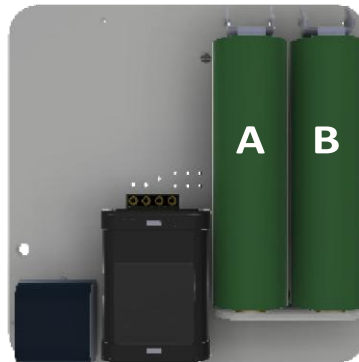

3. Mount the back panel securely to the wall with at least 2 appropriate screws, using some of the four mounting holes. Alternatively, attach the sensor with double sided adhesive tape.



4. Attach the sensor part by hinging it on the back panel.



3.2 Service and Maintenance

There are no serviceable parts inside. If service is needed other than battery replacement, please get in touch with your distributor.

4 Sensor Configuration

All sensor settings can be configured via a smartphone application with NFC (Near Field Communication) or over the air via the network server and downlink data to the sensor. The sampling rate, spreading factor, encryption keys, port, and modes can be changed. All sensor settings can be locked from the server or NFC to make end users unable to read or change settings on the sensor.

4.1 NFC Configuration

1. Download ELSYS “Sensor Settings” application from Google Play or App Store and install it on a smart phone or tablet. The device must support NFC.
2. Enable NFC on the device and start the application.
3. Place your device on top of the EMS sensor to connect with the NFC antenna. Keep the two devices close to each other and don't move them to get as good connectivity as possible. You may need to remove the top cover and battery to get connection.
4. Current settings will be displayed in the application.
5. Use the application to change any settings if needed.
6. Tap the device on top of the NFC antenna to send the new settings to the sensor. Make sure that the application confirms your new settings.
7. Wait for the sensor to reboot (1-5 sec), indicated by the LED flashing. Sensor settings have been updated. Always validate your settings by reading the NFC data after the sensor has restarted.

See the section “Help” in the application for more information.



4.2 Over the Air Configuration

All settings may be configured over the air via your LoRaWAN® infrastructure. Please visit the support section on our webpage for more information regarding downlink protocol.

4.3 Application Parameters

All parameters for the “Sensor settings” application can be found in our settings document. Please visit the support section on our webpage for more information.

5.1 Display

The ERS Display Series LoRa sensors have a 2.13” E-paper display, which keeps the onscreen information even if the sensor is unpowered.

The display will have four different modes depending on the current state of the sensor.

Factory mode: If the sensor is not yet started. See figure 1.

Join mode: When the sensor is trying to join the network. See figure 2.

Standard mode: During normal operation, the layout and values presented on the screen will depend on the sensor model and configuration. See figure 3, 4 and 5.

Low Battery mode: If the sensor detects that the battery voltage is getting close to the limit of operation, the sensor will set the screen to display information that the battery needs to be replaced. It will not recover from this mode until the batteries are replaced. See figure 6.

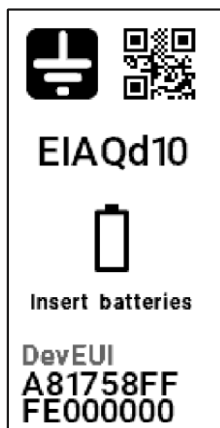

Figure 1



Figure 2

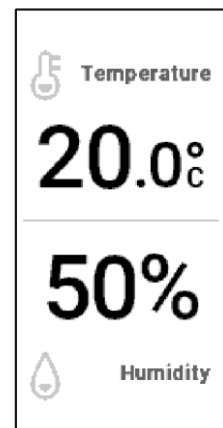

Figure 3

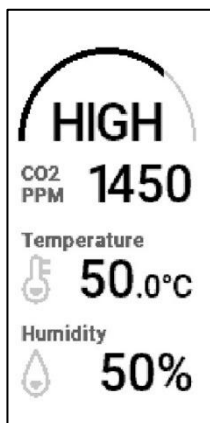

Figure 4

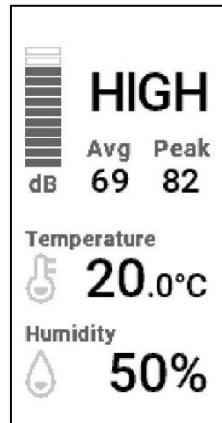

Figure 5

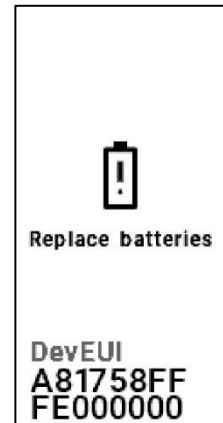

Figure 6

The sensor will perform a full refresh of the screen every 72nd time it updates. During a full refresh, the display will flash back and forth between completely black and completely white before the new content is shown.

5.2 Onscreen sensor data

The display is updated on a multiple of the main time base, which will be 1 by default. The onscreen values are the most recently measured as decided by the internal sensors' sample periods. The temperature unit can be configured to be shown as either Celsius or Fahrenheit. On-screen text information in standard mode can be selected by the user. Available languages are English, German, French, Italian and Spanish.

5.2.1 ERS Display Lite LoRa, ERS Display LoRa, ERS Touch LoRa

The ERS Display Lite LoRa, ERS Display LoRa and ERS Touch LoRa displays temperature and humidity.

5.2.2 ERS Display Co2 Lite LoRa, ERS Display CO2 LoRa

The ERS Display CO2 Lite LoRa and ERS Display CO2 LoRa will display temperature, relative humidity, and CO2 levels. The numeric CO2 levels in parts per million are displayed alongside text that will change depending on the CO2 level and user-selectable thresholds. The text indicators are LOW, MID, and HIGH.

5.2.3 ERS Display Sound LoRa

The ERS Display Sound LoRa will display temperature, relative humidity, average, and peak sound levels. The numeric sound levels are displayed alongside text that will change depending on the average sound level and user-selectable thresholds. The text indicators are LOW, MID, and HIGH.

5.2.4 ERS Display VOC LoRa

The ERS Display VOC LoRa will display temperature, relative humidity, and VOC levels. The numeric VOC levels in parts per million are displayed alongside text that will change depending on the VOC level and user-selectable thresholds. The text indicators are LOW, MID, and HIGH.

5.3 Custom Interface

All ERS Display Series LoRa sensors support adding custom information to the interface.

The custom information can be updated via downlink, allowing the ERS Display Series LoRa sensors to be tailored to a wide variety of use cases.

The custom interface feature is designed for minimal downlink size, making it possible to update the on-display information on high spreading factors.

Custom information can be added anywhere on the interface and is placed on top of the default interface.

The available custom interface commands are:

- Add text field
Can be added in different sizes, colors and with different alignment.
- Add text to text field
Places text in the text field to be displayed for the end user
- Add internal sensor data to text field (see §7 for available internal sensors)
Automatically updated when the internal sensors are updated
- Add Shapes (Rectangles, circles, lines)
Can be used to cover parts of the original interface, create graphs or change the look of the interface
- Add Special icons
Adds one of a number of pre-defined icons to the interface
- Logotype placement
Changes the placement of the logotype
- Toggle item on/off
Enables adding/removing items to the interface without removing the information from the sensor's internal memory
- Save interface
Makes the current custom interface configuration reboot persistent.

For more information on the custom interface, contact the Elsys sales team.

6.1 Sensor Startup

1. The display will be set to factory mode before the sensor is powered for the first time.
2. When the sensor starts, it loads configuration parameters stored in the NFC chip. The sensor will then write all configuration parameters back to the NFC chip.
3. When the configuration is done, the sensor tries to join the network if OTAA (Over the Air Activation) is enabled. Ensure that the sensor credentials (DevEUI, AppKey, JoinEUI) match the keys added to the server to activate the device. The join procedure starts at spreading factor 7 with a join request every ~15 seconds. The sensor will gradually increase the time and the Spreading Factor between the following join requests until the join is successful. An orange LED blink indicates every join request.
The sensor starting the join procedure will be indicated on display with the join mode screen.
4. After a successful connection to a network, the sensor sends an uplink containing the sensor settings and enters sampling mode. The screen enters its default mode of showing sensor data.

6.2 Sampling mode / Periodic measurement

The sensor makes periodic measurements according to the user configuration

6.3 Scheduled Transmission

The sensor transmits the data according to the user configuration. However, the configured sending interval can be overridden by network limitations. Due to this, the spreading factor and sending interval settings might result in longer intervals than intended.

6.4 LED Indication

LED Indicator	Action
Red/Green Sequence	Sensor is starting up
Short Orange Blink	LoRa Join Request Transmission
Short Green Blink	LoRa Uplink Transmission
Short Red Blink	Sensor failed to send an uplink. Common cause is duty cycle limits.
Long Blue Blink	Sensor has loaded new configuration from NFC

7.1 Temperature Sensor

Resolution	0.1 °C
Accuracy	0.2 °C typical, see figure 7

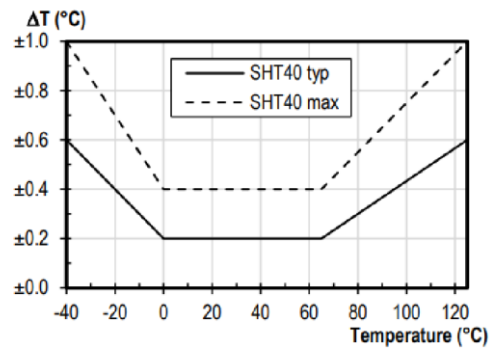

Figure 7

7.2 Humidity Sensor

Resolution	1 % RH
Accuracy at 25 °C	±2 % RH, see figure 8

For accuracy of RH over temperature, see figure 9

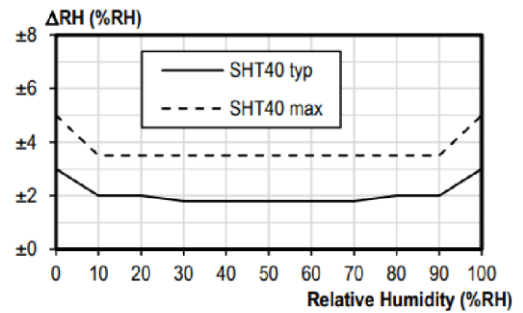

Figure 8

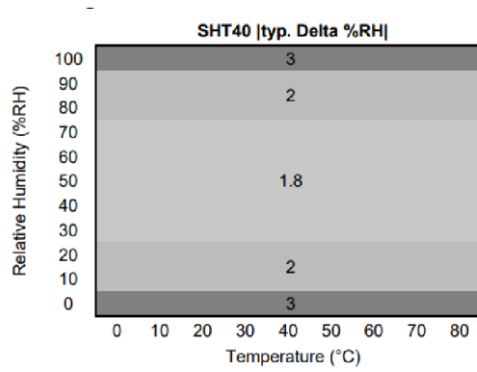

Figure 9

7.3 Light Sensor

Range	0 - 65535 lux
Accuracy	± 10 % or ± 10 lux, whichever is greater.

The light sensor sits behind the PIR lens. For correct reading, make sure it isn't obstructed. Accuracy can depend on angle of light source.

7.4 CO₂ Sensor

Range	400 - 5000 ppm
Accuracy	30 ppm, ±3 % of reading (15-35 °C, 0-80 % RH)

The CO₂ sensor normally runs an automatic baseline correction algorithm (ABC), with a period of 8 days. For a fully corrected measurement, the ABC needs 3 consecutive 8-day periods where the sensor sees fresh air sometime during each ABC period. It can also be calibrated manually, and the ABC can be turned off. In this case it is recommended to do manual calibration in fresh air once/year.

7.5 VOC Sensor

Measurement range, Ethanol or Hydrogen in air: 0 - 10000 ppb (0-10 ppm)

Measurement range, IAQ-index: 0 - 7.0 (IAQ index shown as whole numbers from 0-70, divide by 10 to get the index)

The VOC-sensor has a run-in period of at least 48 hours before accurate VOC data is reported.

The VOC-sensor reports an indoor air quality (IAQ) index in addition to the VOC ppm. The index is a composite measure of indoor air quality. It reflects the estimated pollution level, with lower values indicating cleaner air and higher values suggesting greater contamination.

IAQ rating	Air formation	TVOC	Air Quality
≤ 1.9	Clean hygienic air	< 0.3	Very good
2.0 - 2.9	Good air quality	0.3 - 1.0	Good
3.0 - 3.9	Noticeable Comfort Concerns (not recommended for exposure > 12 months)	1.0 - 3.0	Medium
4.0 - 4.9	Significant Comfort Issues	3.0 - 10.0	Poor
≥ 5.0	Unacceptable Conditions	> 10.0	Bad

*Conversion from ppm to mg/m³ for most common TVOC is by the factor approximately 2 (e.g., 1ppm equals approximately 2mg/m³).

7.6 Motion PIR Sensor

Actual range of the sensor can be influenced by environmental conditions. Avoid installing the sensor in areas where it will face direct or reflected sunlight. Avoid installing near windows, air conditioning, or heating vents. Such placements can give false values.

The PIR can cause self-trigger if sensors are placed too close to each other. Keep this in mind when you mount or test the sensors.

The PIR has a blanking time of 8 seconds right after motion event and transmission. Any movements during this time will be ignored.

The PIR is able to detect human motion when the temperature difference increases or decreases between the fields created by the PIR lens.

There are four options for motion detection, Count, Trigger, Trigger Once and Occupancy.

In count mode, the sensor will report the number of times the PIR has been triggered from the last report.

In trigger mode, the sensor will send a triggered uplink each time motion is detected as well as the total number of triggers for the elapsed period.

In trigger once mode, the sensor will send one triggered uplink each report period, as well as the total number of triggers for the elapsed period.

In occupancy mode, the sensor reports occupancy data. Occupancy has three levels, 0, 1 and 2.

Occupancy is incremented when motion is detected and decreased when no motion is detected after a (selectable) period of time.

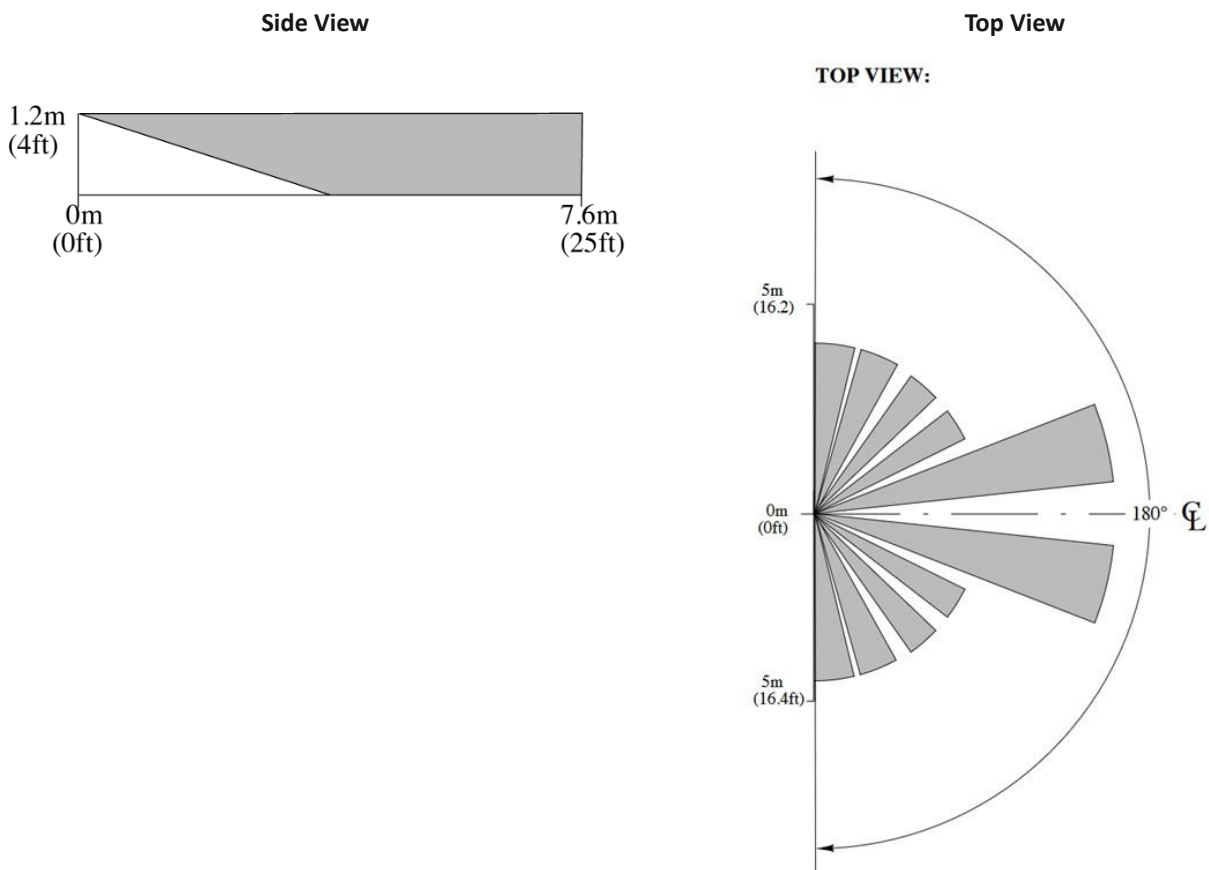

7.7 Sound Level Sensor

Average Value Range	32 - 75 dBspl
Peak Value Range	60 - 99 dBspl
Filtering	dBal
Sound Resolution	1 dB
Sound Accuracy	±5 dB

The sound level sensor continuously measures the average and peak sound pressure level with no missing events. The analog part is always on, with a peak-hold circuit for peak level, and a mean-value filtering for average value. The digital part wakes and samples both signals every 10 s and does the final calculation before sending the data at the desired send interval.

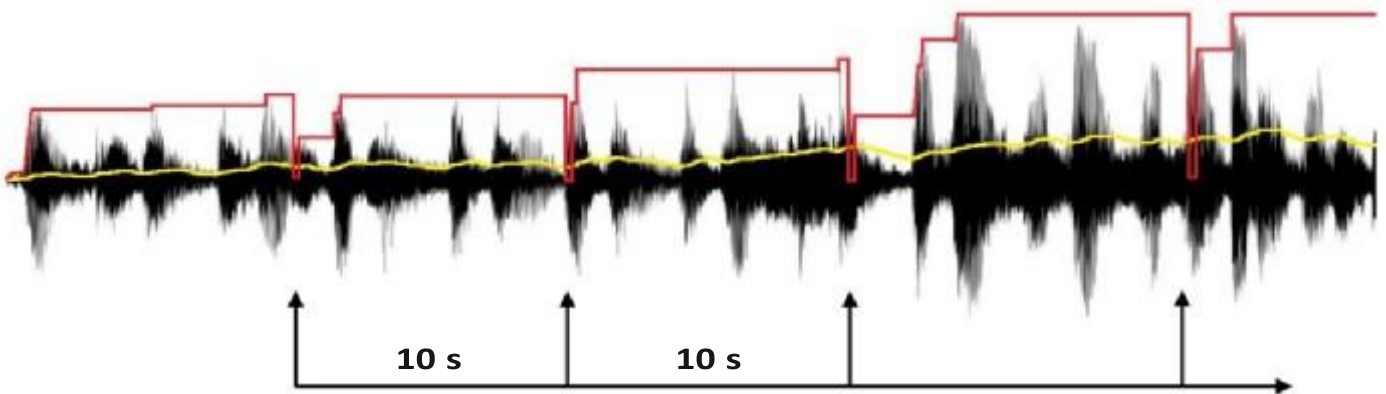

10 s sample and peak reset. For every send interval, it calculates total peak and average for all samples. Red = peak, yellow = average.

8.1 Specifications

Dimensions	76,2 x 76,2 x 22,5 mm
Weight	53 - 60 g excluding batteries 70 - 95 g including batteries
Enclosure	Plastic, PC/ABS
IP Rating	IP30
Mounting	Screws/Adhesive tape
Recommended installation height	Wall: 1.6 m
Usage Environment	Indoor
Operating Conditions	0 to 50 °C 0 to 85 % RH (non-condensing)
Operating Voltage	3.6 V DC
Battery Type	AA 14505 Li-SOCl ₂
Battery Life	Up to 10 years (Depending on settings and environmental factors)
Wireless Technology	LoRaWAN® 1.0.4, Regional Parameters RP2 - 1.0.3
Wireless Security	LoRaWAN® End-to-End encryption (AES-CTR), Data Integrity Protection (AES-CMAC)
LoRaWAN® Device Type	Class A End-device
Supported LoRaWAN® regions	EU868, IN865, US915, AU915, AS923, HK923, KR923
Supported LoRaWAN® features	OTAA, ABP, ADR, Adaptive Channel Setup
Link Budget	137dB (SF7) to 151 dB (SF12)
RF Transmit Power	Max 14 dBm EIRP
EU Directives Compliance	RED 2014/53/EU, RoHS 2011/65/EU, WEEE 2012/19/EU

8.2 Sensor Payload Format

The device uses the standard ELSYS payload format. Please see the specified document on our webpage.

9.1 Legal Notices

All information, including, but not limited to, information regarding the features, functionality, and/or other product specification, are subject to change without notice. ELSYS reserves all rights to revise or update its products, software, or documentation without any obligation to notify any individual or entity. ELSYS and ELSYS logo are trademarks of ElektronikSystem i Umeå AB. All other brands and product names referred to herein are trademarks of their respective holders.

9.2 Federal Communication Commission Interference Statement

Notice

This device complies with Part 15 of the FCC Rules and with Industry Canada licence-exempt RSS standard(s). Operation is subject to the following two conditions:

- (1) this device may not cause harmful interference, and
- (2) this device must accept any interference received, including interference that may cause undesired operation.

Le présent appareil est conforme aux CNR d'Industrie Canada applicables aux appareils radio exempts de licence. L'exploitation est autorisée aux deux conditions suivantes:

- (1) l'appareil ne doit pas produire de brouillage, et
- (2) l'appareil doit accepter tout brouillage radioélectrique subi, même si le brouillage est susceptible d'en compromettre le fonctionnement.

FCC ID

2ANX3-ERSD1

IC ID

26904-ERSD1

Note

Changes or modifications made to this equipment not expressly approved by ElektronikSystem i Umeå AB may void the FCC authorization to operate this equipment.

9.3 Declaration of Conformity

Hereby, ElektronikSystem i Umeå AB declares that the radio equipment type "Radio communication devices for low-speed data R&TTE Class 1" is in compliance with Directive 2014/53/EU, Directive 2011/65/EU and Directive 2012/19/EU.

The full text of the EU declaration of conformity is available at: <https://www.elsys.se/link/eu-doc>

Revision	Description	Date
1.0	Display Series operating manual Created	2023-08-24
2.0	Added Custom interface, changed pictures	2025-04-23
2.1	Added note about display, and battery.	2025-04-24
2.2	Added table for VOC	2025-04-24